

# THREE TIER CARPET TREE

assembly instructions

Your new Three Tier Carpet Tree is easy to assemble

## contents

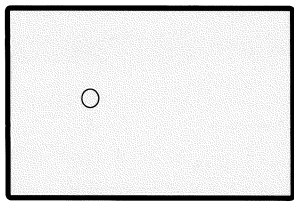

Platform (3 pcs.)

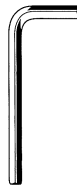

Allen Wrench

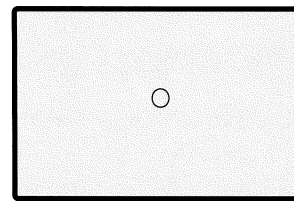

Base (1pc.)

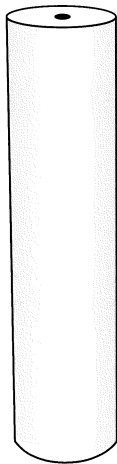

Interchangeable Tube 21.7"(3 pcs.)

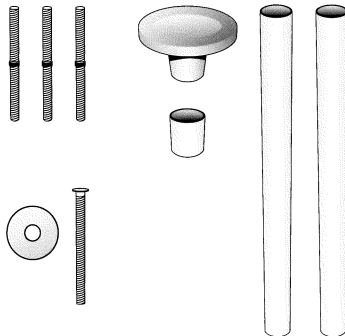

Hardware (9 pcs.)



Top Tube 21.7"(1 pc.)

You will need a sturdy ladder...be careful.

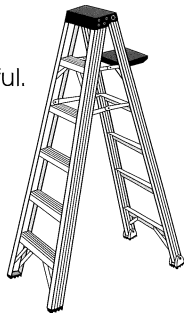

If your ceiling is less than 9 feet but more than 8 feet you will need a hacksaw.

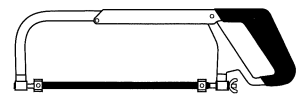

**CAT CRAFT™**  
by One Source International

Part# 124003